

# Development of a micro annular gear pump by micro powder injection molding

T. GIETZELT, O. JACOBI, V. PIOTTER, R. RUPRECHT, J. HAUSSELT  
*Forschungszentrum Karlsruhe, Institut für Materialforschung III, P.O. Box 3640,  
 76021 Karlsruhe, Germany*  
*E-mail: thomas.gietzelt@imvt.fzk.de*

Scaling down devices from the macroscopic world to microsystems presents various problems since tolerances decrease down to the range of the surface roughness. Consequently, the problems assembling such systems increase and any wear has an extreme impact on the function of microsystems. Recently, most microparts are made of thermoplastics or in brittle materials like silicon by deep etching. The mechanical properties of these materials, however, are not favorable for microparts subjected to mechanical wear. To meet the obvious demand for wear resistant microparts made of metals and ceramics, the development of Micro-Metal Injection Molding (Micro-MIM)/Micro-Ceramic Injection Molding (Micro-CIM) was started at Forschungszentrum Karlsruhe a few years ago. The article describes special distinctions between Micro-Powder Injection Molding ( $\mu$ -PIM) and normal PIM as well as the arising process variations.

However, one has to keep in mind the shrinkage during the PIM-route that makes it very difficult to meet the small tolerances required.

In this paper the results of a demonstrator development of a micro annular gear pump and the adaptation for micro ceramic injection molding (Micro-CIM) are reported. For CIM, mold inserts made by LIGA were used. The quality of the molds was evaluated by SEM and micro injection molding in PMMA. Subsequently, Micro-CIM was carried out using zirconia feedstocks. The microparts were separated from the substrate, debound, sintered and surface finished. The surface roughness was evaluated and the processes were optimized.

© 2004 Kluwer Academic Publishers

## 1. Introduction

Microsystem technology is one of the leading technologies of the 21st century. Market analysis, for example, predicted a steady yearly growth of 18% of the market volume reaching 40 billion US\$ in near future [1].

Recently, most micro systems are made of thermoplastics because they can be easily processed by micro injection molding due to of their low viscosity. Microsystems made of silicon by deep etching, a technique originating from micro electronics, are also presented [2]. However, the mechanical properties e.g., low wear resistance and excessive brittleness should prevent a reasonable lifetime of microsystems made of these materials.

PIM is a near net shape manufacturing process and well established for large scale production. Limitations arise from multiple operation steps from raw material to the final part incorporating powder production, feedstock preparation, injection molding, debinding, sintering and sometimes finishing, see Fig. 1. The PIM-process uses feedstocks, consisting of a polymeric binder and metal or ceramic powders. Usually, the feedstock contains 50–60 vol% of powder depending on particle shape and particle size distribution.

After injection molding, most of the binder is removed from the green part. A so-called brown part consisting of the powder particles, a network of pores and a residual amount of binder, giving the particle network of the part a sufficient strength for handling is formed. Subsequently all binder is burned out and the part is sintered to nearly full theoretical density. Because of the high porosity, the linear shrinkage of the parts is about 15–22%. The achievable precision to meet tolerances or dimensions is about  $\pm 0.3\%$  [3, 4]. Consequently, it is very difficult to meet small dimensional tolerances exactly.

PIM is a very favorable process for relatively small and complex shaped parts especially made of ceramics since handling expenses for ceramic parts can reach up to 80% of the overall costs [5].

For Micro-PIM of real 2.5d structures with a large surface to volume ratio, however, additional process variations are required arising from the high content of inorganic powder in the feedstock and the physical properties like high thermal conductivity and density gradients:

- To replicate micro features the powder particle size becomes significant because features are in the

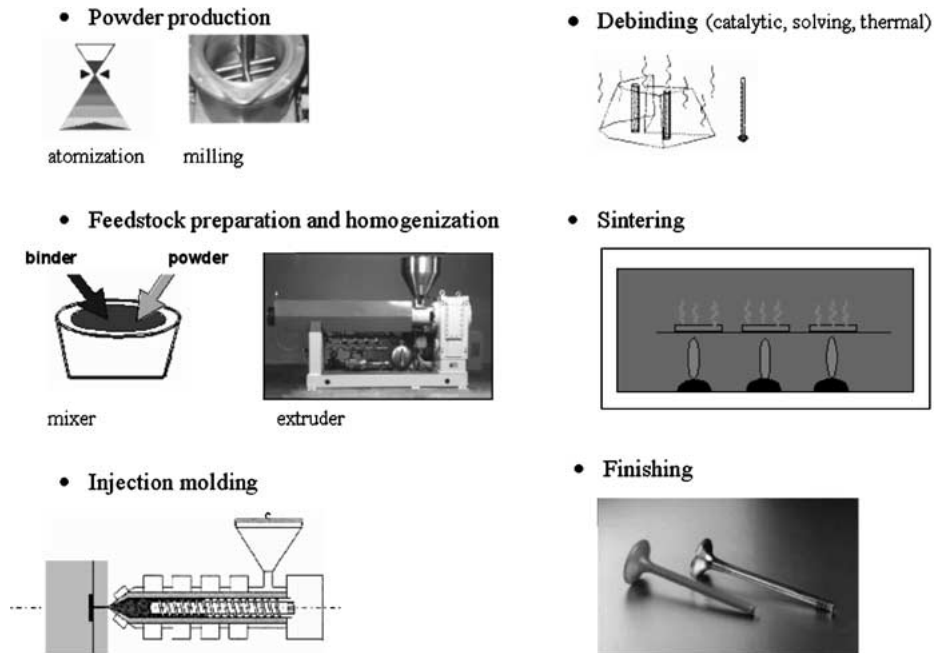

Figure 1 PIM-route.

range of the surface roughness for normal PIM applications. By using coarse powders no good profile quality could be obtained. For micro features the average particle size should be one to two magnitudes smaller than the structural details. Sometimes very fine powders in the submicron range are required [6].

- The strength of the feedstock is mainly controlled by the interfacial strength of the inorganic particles and the binder matrix. For demolding microparts without flaws, the feedstock has to have a sufficient strength.
- Micro-PIM of complex microcomponents has to be carried out at elevated tool temperatures to prevent freezing of the feedstock before filling all details of the mold. The tool temperature has to be in the range of the glass transition temperatures or the crystallite melting point depending on the type of thermoplastics used as a binder in the feedstocks. Prior to demolding, the injection molding tool has to be cooled down to a demolding temperature determined by the material and the specific microstructures. This tempering cycle leads to relatively long cycle times in micro injection molding and has to be compensated by e.g., increasing the number of microstructured mold cavities [7, 8].
- Micro structures represent “blind holes” which are filled from the face of the mold insert. Normally the trapped air in the mold can escape through the dividing plane when injecting. For Micro-PIM, however, any gap must be avoided because it would be filled by the feedstock. Therefore, the tool has to have a sealing and the machine periphery must be equipped with a vacuum unit to be able to evacuate the mold prior to injection molding to avoid the so-called Diesel-effect [7, 8].
- Using conventional injection machines for micro parts the predominant amount of feedstock

is needed for the runner system and supporting structures. Additionally, the residence time of the thermoplastic material is increased leading to degradation and reduced properties of the parts [9]. Sometimes the micro parts cannot be molded separately but are placed on a base plate. The costly rework for isolating should be avoided using smaller injection molding machines especially adapted to micro injection molding.

This article describes the development of Micro-CIM for the fabrication of isolated microparts for a micro annular gear pump. The microparts were made of zirconia with a desired thickness of  $500\ \mu\text{m}$  by Micro-CIM.

New methods for the finishing of ceramic microparts with very tight tolerances as well as the assembling of components of a micro annular gear pump had to be developed and are reported.

## 2. Design and preparation

Fig. 2 shows an exploded view of the micro annular gear pump. The diameter of the housing parts is 3.2 mm. The housing parts should be fixed using pins. More dimensions of microcomponents are given in Fig. 3. A

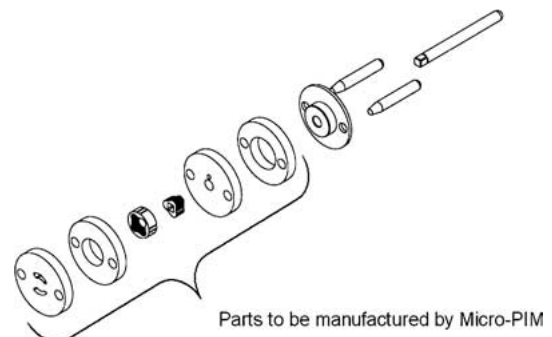
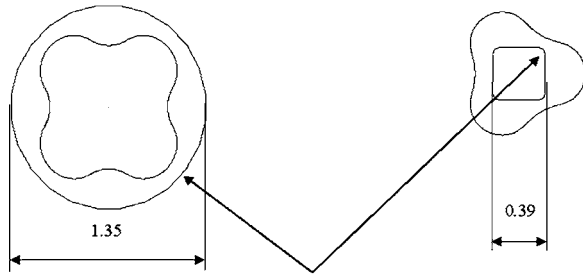

Figure 2 Exploded view of the micro annular gear pump.



minimal wall thickness: 80  $\mu\text{m}$

Figure 3 Detail of the micro annular gear pump.

minimal wall thickness of approximately 80  $\mu\text{m}$  at the rotors arises.

Because the power loss of the micro annular gear pump increases with the second order of the gaps between moving parts, the tolerance between moving parts has to be as small as possible.

The gaps between external and internal rotors, as well as between external rotor and rotor housing were defined to be less than 3  $\mu\text{m}$ . Note that both rotors also have to be less than 3  $\mu\text{m}$  thinner than the rotor housing to prevent jamming.

To guarantee the adjustability of two tolerances between three parts, only one dimension per part can be varied. Since the available space for microparts on a LIGA-mold insert is limited to 20 mm times 60 mm only small parts can be varied. Hence, both the outlines of the internal as well as the external rotor were changed. Variations were made by equidistant offsets of the shape in steps of 1  $\mu\text{m}$  resulting in diameter variations of 2  $\mu\text{m}$  for each part. For the internal rotor seven variations were made; for the external rotor, however, only four variations were made for reasons of limited space. The principle of adjusting the tolerances is displayed in Fig. 4 by picking the appropriate internal rotors to adjust the gap to the external rotor and picking the appropriate external rotor to adjust than the gap to the rotor housing.

For the set of micro components displayed in Fig. 4 two growth factors were applied to compensate the shrinkage for two materials: alumina and zirconia.

Mostly not all micro features on a LIGA-mold insert are without fault. Therefore, the rotor housing was realized twice since it was the most critical part for being able to assemble the micro gear pump at all.

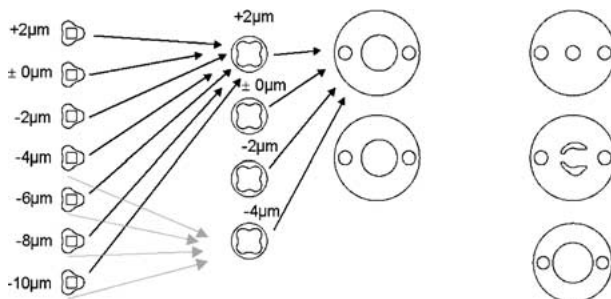

Figure 4 Design variations of moving parts of the micro annular gear pump. Tolerances of the outline of internal as well as external rotors in micrometer relate to appropriate holes leading to corresponding gaps between moving parts. Normally only negative values would give a gap and hence a working micro annular gear pump.

TABLE I Catamold<sup>®</sup>-Feedstocks used

Catamold <sup>®</sup> -Feedstock	Material
AO-F	Al <sub>2</sub> O <sub>3</sub>
TZP-A	ZrO <sub>2</sub>

### 3. Methods and procedures

The development was started with a commercially available, polyacetal-based system by BASF.

The mold insert was made by the LIGA-Process using PMMA as resist and electroplated in nickel. Fig. 5 shows a mold insert with a depth of 650  $\mu\text{m}$ . The LIGA-process is described in detail in [10, 11].

Injection molding was carried out on a Ferromatik Milacron “K50” at 175°C feedstock temperature at the nozzle, a tool temperature of 150°C and a specific injection pressure of approximately 700 bar. Demolding was carried out at 60°C. The use of a 50t injection molding machine leads to a disproportional amount of scrap related to the parts manufactured due to the runner system. Additionally, the injection process is hard to control since the micro parts are filled last. At this spot default values of temperature of the feedstock and pressure are not well defined. Instead injection molding machines especially designed for micro injection molding like the “Microsystem 50” of “Battenfeld” would be the best choice. Unfortunately, a machine of this type was not yet available at the start of the project.

Following demolding, the part was frozen upside down on a stage using a Kryo-Tool by “Lotsch and Partner” and the substrate was milled off using a diamond tool. The machining of green parts is a rather complex process: The hard inorganic particles are pulled out of the soft polymeric binder matrix. Hence, the surface quality is determined by cutting speed, workpiece feed and last but not least by the particle size of the inorganic powder particles. However, this is not a problem for ceramic feedstocks, since ceramic powders used for Micro-CIM are in the submicron range.

Fig. 6 shows a set of microparts for a micro annular gear pump made of alumina.

From former investigations of another demonstrator it was known that for the alumina feedstock distortions occur during sintering. Krug *et al.* had shown that the effect is due to irregular alumina powder particles of Alcoa CT3000SG leading to orientation effects along the cavity wall and hence to density gradients in the green part during injection molding [12].

As a consequence, the alumina feedstock was abandoned in favor of zirconia feedstock known for far better results.

For debinding and sintering purposes the isolated microparts were placed on a magnesia plate and debound in an acid atmosphere. For this, 20 ml of water free, fuming nitric acid were dosed at a rate of 0.25 ml/min at 110°C to decompose the polyacetal binder of the feedstocks.

Afterwards the parts were sintered, using a tube furnace. The sinter conditions for zirconia are shown in Table II.

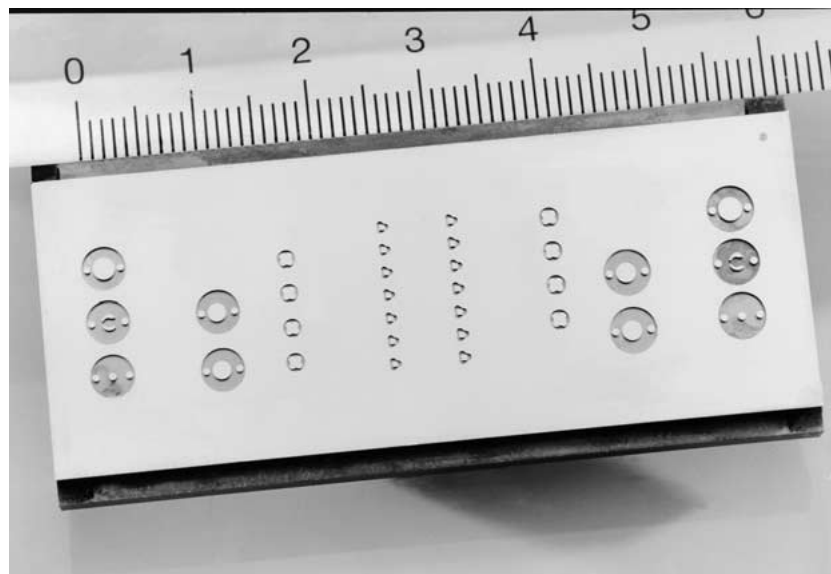

Figure 5 LIGA-mold insert of the micro annular gear pump.

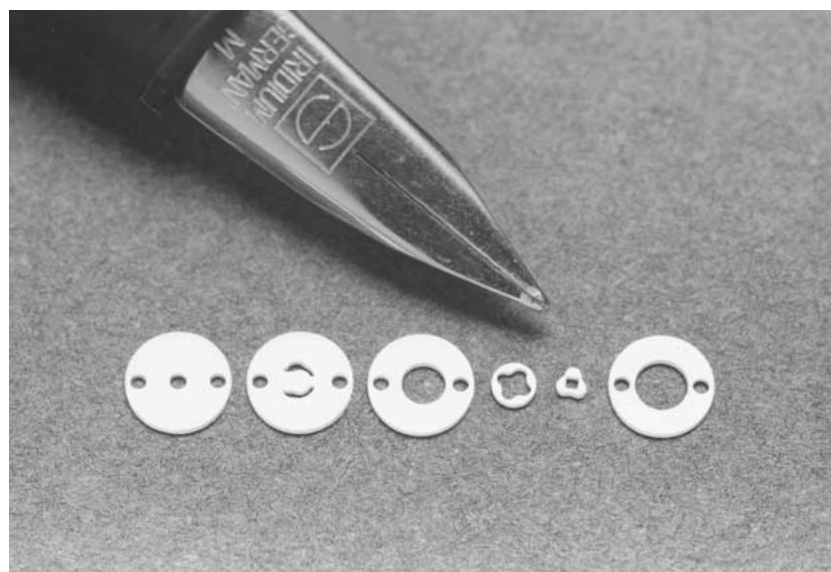

Figure 6 Isolated microcomponents of a micro annular gear pump.

Surface investigations using a FRT-Microglider showed a very good flatness and surface quality of the sintered microparts made of zirconia as displayed in Fig. 7.

However, to be able to assemble a micro annular gear pump the profile perpendicular to the surface must be strictly controlled as well. Fig. 8 shows the result of the surface evaluation of the shell of an internal rotor. As can be seen, the profile over the height of the micropart of approximately 450  $\mu\text{m}$  is  $\pm 1 \mu\text{m}$ .

TABLE II Sinter condition for Catamold<sup>®</sup> TZP-A [13]

Rate (K/min)	Setpoint ( $^{\circ}\text{C}$ )	Dwell time (h)
1	270	1
2	600	1
5	800	
2	1500	1
3	50	

To meet the tight tolerances required for good efficiency of the annular gear pump, two complete sets of microparts were fixed at once on a glass substrate of three inch diameter by means of a special wax for the finishing operation steps. The challenge is to fix several microparts without tilting and flat on a glass substrate. Since the microstructured surface of a LIGA-mold insert has a deflection of about 10  $\mu\text{m}$  due to intrinsic tensions arising from electroplating [14] the microparts do not have the same height in the micrometer range after isolation (see Fig. 9) although the green parts were cut into segments of about 20 mm length. Hence, no rigid weight can be used to force down the microparts to the glass substrate. If any inclination of the fixed microparts would emerge, wedge-shaped microparts would result after finishing the first side. When repeating the procedure for the second side, the surfaces of the microparts would be parallel; however, any hole in the microparts would be not perpendicular to the surface preventing the micro annular gear pump to work properly.

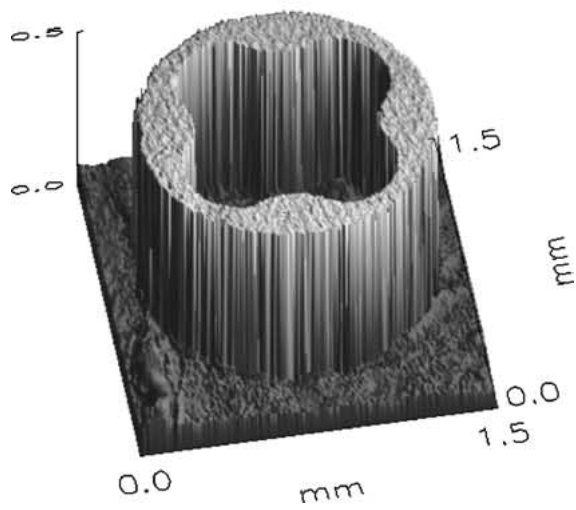
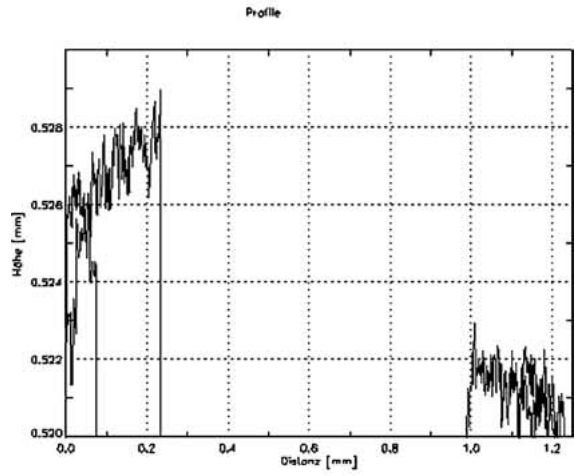
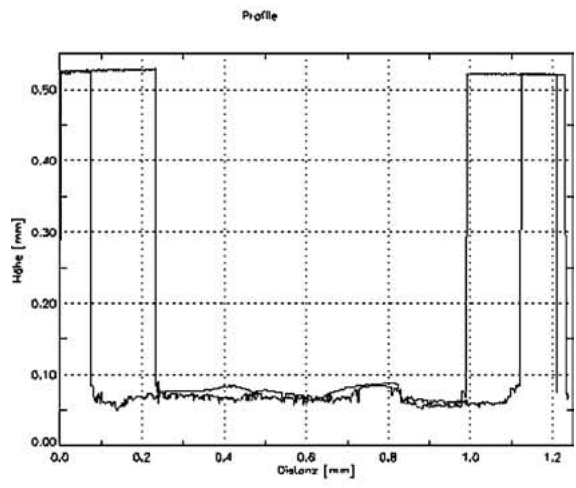
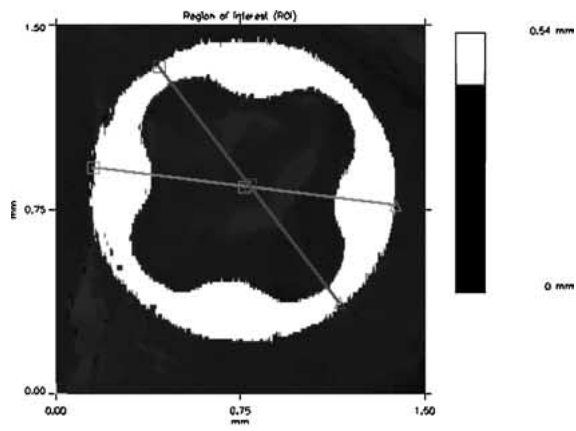

Figure 7 Surface evaluation of a sintered external rotor made of zirconia.

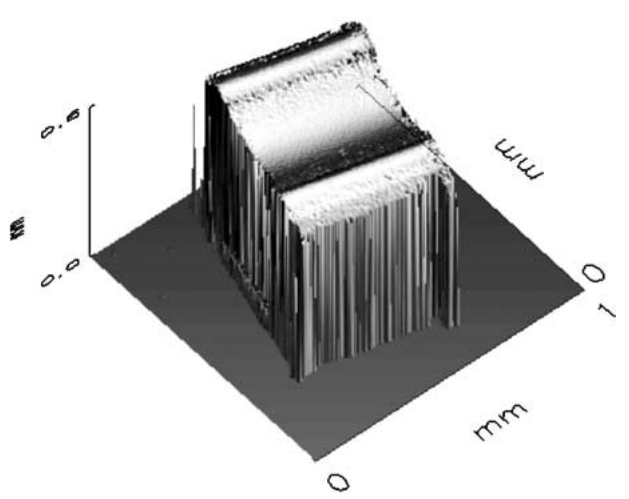
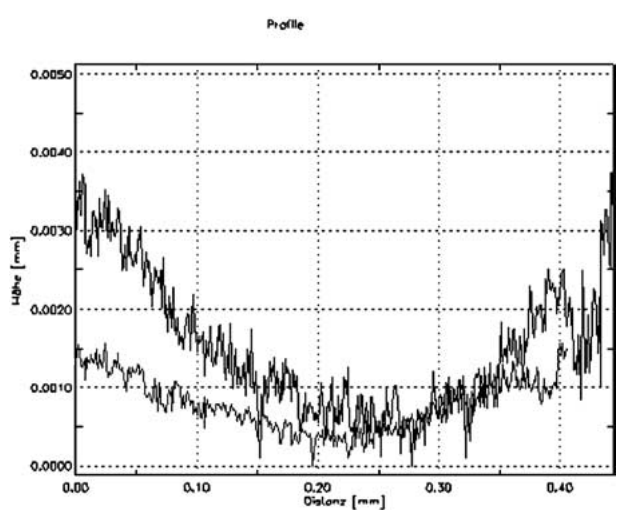
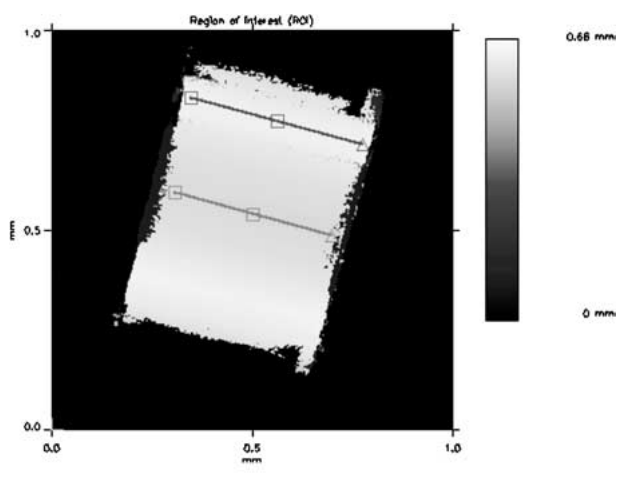

Figure 8 Evaluation of the shell of a sintered internal rotor made of zirconia. Note the y-axis is in micrometer steps!

Therefore, a wafer bonding unit by “Logitech” was used for bonding the microparts to the glass substrate. A flexible rubber membrane was sucked onto the microparts of any height by vacuum forcing them on the glass substrate. Then the stage was heated up to the desired temperature. The wax became fluid and the microparts sank down. Afterwards the stage was cooled down and the glass substrate with the bonded microparts could be released.

The glass substrate was fixed on a vacuum stage on a lapping machine PM 5 by “Logitech” and lapped with

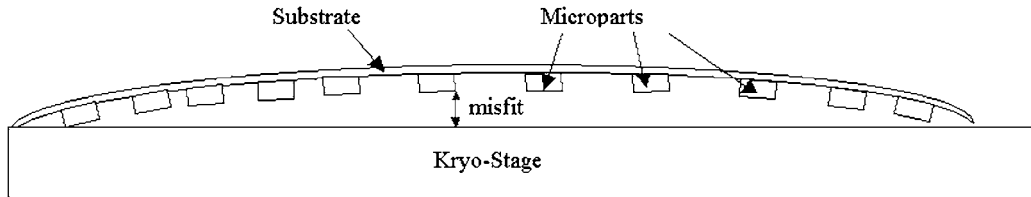

Figure 9 Misfit of micropart height due to curvature of molded parts arising from intrinsic tensions in the mold insert from electroplating. To reduce the misfit, molded parts were cut into sections of about 20 mm.

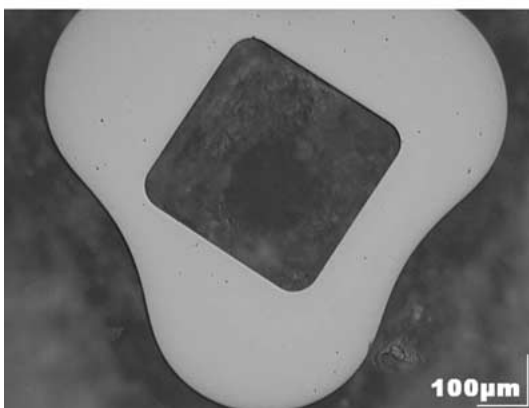
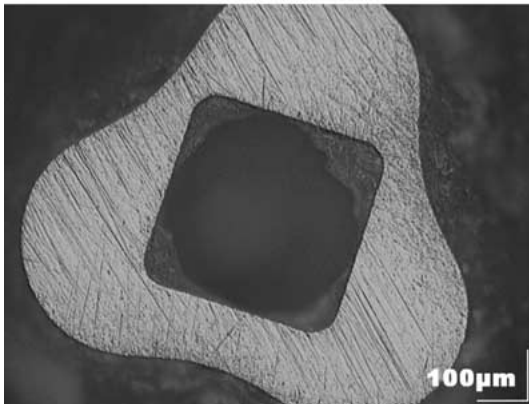
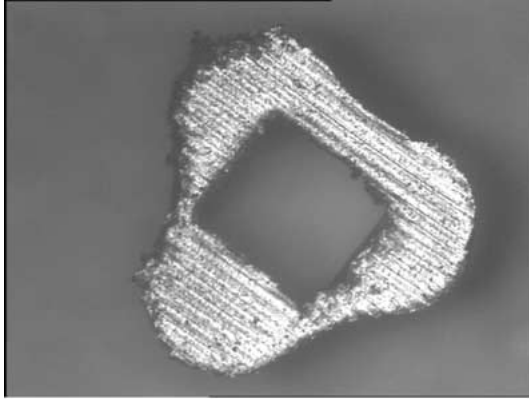

Figure 10 Surface finishing of ceramic microparts made of zirconia (from top to bottom: isolated, lapped, polished).

20 rpm and a load of 1 kg for 10 min using calcined alumina of  $9 \mu\text{m}$  grain size. Then the microparts were checked and the procedure was repeated until the surfaces of all micoparts were lapped properly. For polishing the lapping machine was cleaned very carefully. A polishing disc with polyurethane surface and colloidal  $\text{SiO}_2$ -sol (Syton Typ SF 1) was used at 20 rpm and 1 kg load for 20 min. The resulting surfaces are displayed in Fig. 10.

#### 4. Results and discussion

Using isolated microparts a module of a micro annular gear pump could be assembled as shown in Fig. 11. However, no complete micro annular gear pump with housing was assembled yet.

The surface and edge quality for lapping and polishing is a function of load respectively of lapped area, disc speed, lapping material and material to be lapped. Optimization is needed for each case. However, it turned out that lapping and polishing is the best choice and most efficient way for finishing, regardless of material, if applied appropriately.

At the start of the project no experience for the absolute precision of LIGA regarding very tight tolerances was available. It was not clear whether diffraction effects at the mask, swelling of the resist when electroplating or other undesirable effects would lead to variations of a few microns compared to the CAD-data.

Therefore the diameter tolerances of  $+2$  and  $\pm 0 \mu\text{m}$  of the outline of the internal as well as the external rotor were included which normally would not fit to each other (compare Fig. 4). However, since it turned out that LIGA is absolutely precise in the micrometer range, this is a problem especially for the external rotor because only tolerances of  $-2$  and  $-4 \mu\text{m}$  are useful at all now.

Another problem is the measure tracing for outline differences of  $2 \mu\text{m}$  in diameter. For this, the finishing steps like lapping and polishing as well as absolute cleanliness of the microparts are a prerequisite. Neither the external rotor outline nor the internal rotor outline is strictly circular. For lubrication purposes the external rotor has four flattenings. Therefore, image processing is the best choice to detect different rotor tolerances via the cross sections variation.

From the present point of view oversized rotors are not necessary even if required tolerances are in the micron range. Instead, the space on the LIGA-mold insert should have been used for tolerances of  $-6$  and  $-8 \mu\text{m}$  for the external rotor outline.

#### 5. Conclusions

It was possible to produce isolated ceramic microparts for a micro annular gear pump by micro powder injection molding and to meet very tight tolerances.

LIGA-mold inserts are very precise. Oversized tolerance variations are not necessary and can be saved.

The geometrical precision of the microparts depends not only on the quality of the mold inserts but is also

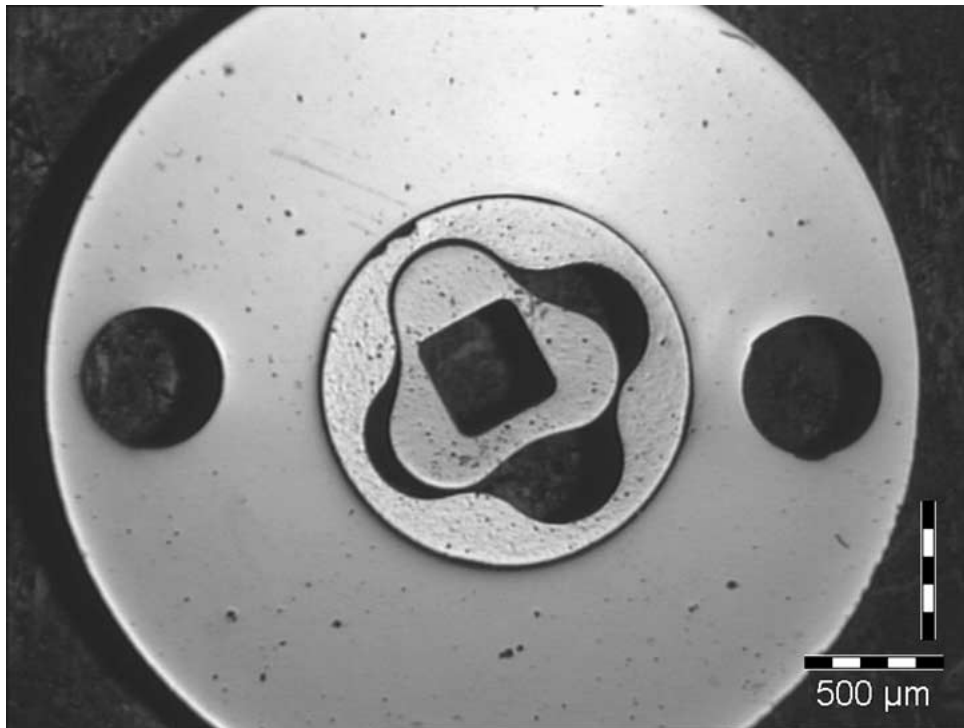

Figure 11 Assembled micro annular gear pump components.

very sensitive to the feedstocks, first of all the particle shape, and to density gradients in the green parts resulting from micro injection molding. Absolute globular powder particles are an essential requirement for high shape accuracy.

Special, for microparts adapted, injection machines like the Microsystem 50 by "Battenfeld" should be preferred to improve the relation of runner system to micropart and improve the overall process control. Thus, the homogeneity of the micropart can be improved and scrap can be reduced.

In the project, a new method for the isolation of microparts was developed. Methods for fixing micro parts onto a substrate in one step very exactly as well as methods for finishing of micro parts of several materials with very high accuracy and very good surface quality were developed and demonstrated.

### Acknowledgement

The project MALVE, subtask B, was funded by the BMBF as a "Strategiefondsprojekt" of the "Hermann-von-Helmholtz-Gemeinschaft Deutscher Forschungszentren" (HGF). We gratefully acknowledge the contribution and support of "Hydraulik Nord Parchim Mikrosysteme" for providing the design. We also thank our colleagues at Forschungszentrum Karlsruhe, GKSS Geesthacht, HMI Berlin and co-operating companies.

### References

1. Nexus Task Force Market Analysis for Micro Systems 1996–2002, October 1998, see also [www.nexus-emsto.com](http://www.nexus-emsto.com).
2. ED VERNON, *et al.*, "Sandia Silicon Micro Chain," see [www.sandia.gov/media/NewsRel/NR2002/chain.htm](http://www.sandia.gov/media/NewsRel/NR2002/chain.htm).
3. MIN SOO PARK and MIN KON LIM, *J. Mater. Sci.* **36** (2001) 5531.
4. S. I-EN LIN, *Ceram. Intern.* **27** (2001) 205.
5. G. WARNECKE, K. EICHGRÜN and L. SCHÄFER, "Zuverlässige Serienbauteile aus Hochleistungskeramik," *Ingenieur-Werkstoffe*, Nr. 2, April 2000 or see [http://fbk.mv.uni-kl.de/keramik/forum/veroe/ing\\_werk/ingwerk.html#wirhart](http://fbk.mv.uni-kl.de/keramik/forum/veroe/ing_werk/ingwerk.html#wirhart).
6. M. STADEL, H. FREIMUTH, V. HESSEL and M. LACHER, *Keramische Zeitschrift* **48**(12) (1996) 1112.
7. V. PIOTTER, T. BENZLER, R. RUPRECHT and J. HAÜBELT, "Manufacturing of Micro Sized Structures by MIM and CIM," *PM<sup>2</sup>TEC'98 International Conference on Powder Metallurgy & Particulate Materials*, Las Vegas, 1998.
8. V. PIOTTER, T. GIETZELT, R. RUPRECHT and J. HAÜBELT, "Tiny Parts Made by Micro Powder Injection Molding," *Proceedings of PM<sup>2</sup>TEC 2001*, New Orleans, 2001.
9. Article "Präzisionssache," *Plastverarbeiter* **52**, Jahrgang (2001) No. 10, p. 142.
10. K. BADE, *Galvanotechnik* **90**(3) (1999) 801.
11. W. EHRFELD, V. HESSEL, H. LÖWE, CH. SCHULZ and L. WEBER, *Microsystem Technologies* **5** (1999) 105.
12. S. KRUG, J. R. G. EVANS and J. H. H. TER MAAT, *J. Europ. Ceram. Soc.* **22** (2002) 173.
13. Data sheet BASF Catamold<sup>®</sup> TZP-A.
14. R. F. A. HAMMOND, *Teil 2, Metalloberfläche* **26** (1972) 291.

Received 1 November 2002  
and accepted 16 September 2003